







Recessed



Softlux S2

IP20 CE

The Softlux 2 Is A Slimline Direct/Indirect Recessed Modular With A Perforated Basket Mounted On Two Outer Edges Which Provides An Aesthetically Pleasing, Discreet Appearance.

-  Body constructed from powder coated zintec steel.
-  Side mounted perforated baffles provide a soft indirect light.
-  Designed to suit both 15mm and 25mm t-bar ceilings.
-  Supplied as standard with leading brand high frequency control gear.

Available options

-  Energy saving control gear options including analogue dimming, digital dimming, movement and daylight sensing.
-  Wiring configurations such as dual circuit, through wiring and various plug and socket choices all aimed at saving time and effort at installation stage.

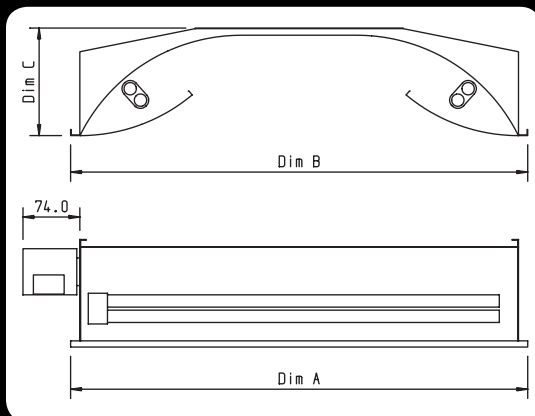
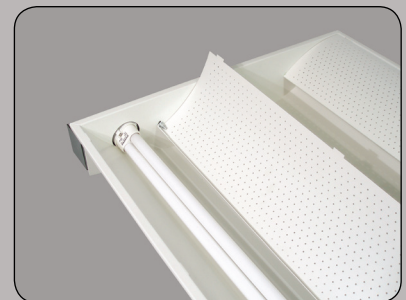

Order Code	Dim A	Dim B	Dim C	Lamps	Wattage
S2i214	595mm	595mm	140mm	2	14w T5
S2i224	595mm	595mm	140mm	2	24w T5
S2i414	595mm	595mm	140mm	4	14w T5
S2i424	595mm	595mm	140mm	4	24w T5
S2i240	595mm	595mm	140mm	2	40w PLL
S2i255	595mm	595mm	140mm	2	55w PLL

Control Suffix

DA	DALI Dimmable
DSI	DSI Dimmable
TD	Touch Dimmable
AD	1-10v Analogue Dimmable
EL	3 Hour Integral Emergency
ELST	Self Test Emergency 3 Hour