









**Recessed**

# Softlux S5

IP20 CE

The Softlux 5 Is A Slimline Direct/Indirect Recessed Modular Incorporating A Captive Cat2 Louvre Mounted In A Perforated Central Basket Making For A Practical, Aesthetically Pleasing Luminaire Which Aids In The Design Of Any Lg7 Application.

-  Body constructed from powder coated zintec steel.
  -  Shootbolt retained Ig7 (2007 65 deg cut off) louvre for ease of fit and better security.
  -  Designed to suit both 15mm and 25mm t-bar ceilings.
  -  Supplied as standard with leading brand high frequency control gear.
  -  Direct/indirect light distribution as standard.
- Available options ....**
-  Energy saving control gear options including analogue dimming, digital dimming, movement and daylight sensing.
  -  Wiring configurations such as dual circuit, through wiring and various plug and socket choices all aimed at saving time and effort at installation stage.

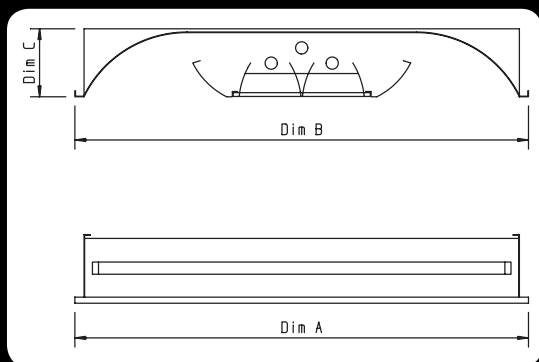
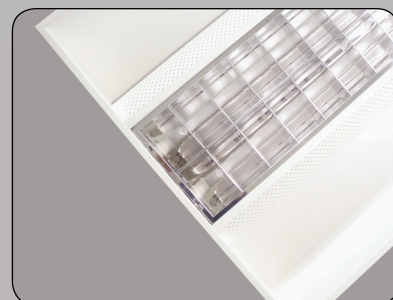

Order Code	Dim A	Dim B	Dim C	Lamps	Wattage
S5i214	595mm	595mm	90mm*	2	14w T5
S5i224	595mm	595mm	90mm*	2	24w T5
S5i414	595mm	595mm	90mm*	4	14w T5
S5i424	595mm	595mm	90mm*	4	24w T5
S5i140	595mm	595mm	90mm*	1	40w PLL
S5i155	595mm	595mm	90mm*	1	55w PLL
S5i240	595mm	595mm	90mm*	2	40w PLL
S5i255	595mm	595mm	90mm*	2	55w PLL

\*Height for emergency 135mm

**Control Suffix**

DA	DALI Dimmable
DSI	DSI Dimmable
TD	Touch Dimmable
AD	1-10v Analogue Dimmable
EL	3 Hour Integral Emergency
ELST	Self Test Emergency 3 Hour