









Exterior

DCR Hood IP65 CE

The DCR Hood Is A High Quality, Robust, Cast Aluminium Bulkhead Available In A Range Of Lamp Types To Suit Any Application.

-  Body constructed from black die cast aluminium.
-  Toughened front opal polycarbonate diffuser.
-  Supplied as standard with leading brand high frequency control gear.

Available options

-  Energy saving control gear options including analogue dimming and digital dimming.
-  Various compact fluorescent lamp type and wattage choices.
-  Also available in silver finish.

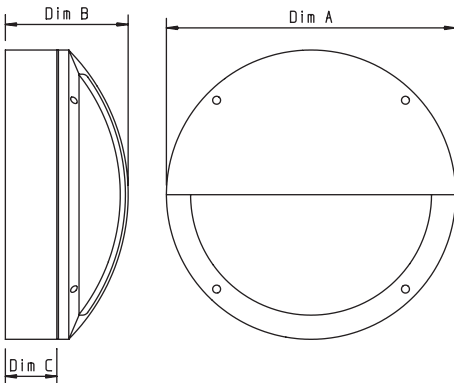
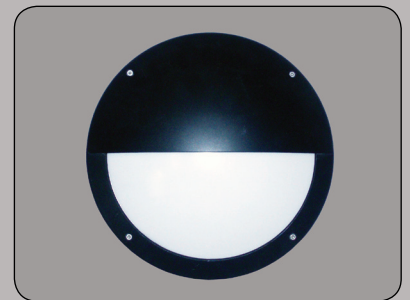

Order Code	Dim A	Dim B	Dim C	Lamps	Wattage
DCRH128	365mm	155mm	65mm	1	28w 2D
DCRH138	365mm	155mm	65mm	1	38w 2D
DCRH132	365mm	155mm	65mm	1	32w PLT
DCRH142	365mm	155mm	65mm	1	42w PLT

Body Style Suffix

S Silver Body

Control Suffix

DA	DALI Dimmable
DSI	DSI Dimmable
TD	Touch Dimmable
AD	1-10v Analogue Dimmable
EL	3 Hour Integral Emergency
ELST	Self Test Emergency 3 Hour