









Racklite

IP20 CE

The Racklite Luminaire Is A Fluorescent Luminaire Particularly Suited To The Illumination Of Areas With Racking Aisles Such As Stores Or Warehouses.

-  Body constructed from white coated steel.
-  High output aluminium reflector.
-  Supplied as standard with leading brand high frequency control gear.
-  Designed for surface, conduit, beza, threaded rod or suspension mounting.

Available options

-  **High rack or white reflectors available.
-  Energy saving control gear options including analogue dimming, digital dimming, movement and daylight sensing.
-  Wiring configurations such as dual circuit, through wiring and various plug and socket choices all aimed at saving time and effort at installation stage.

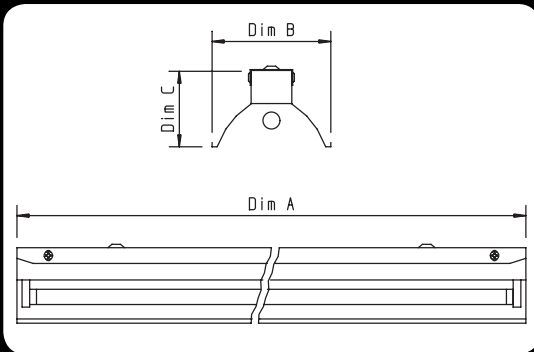
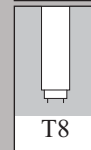
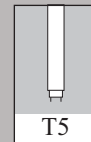
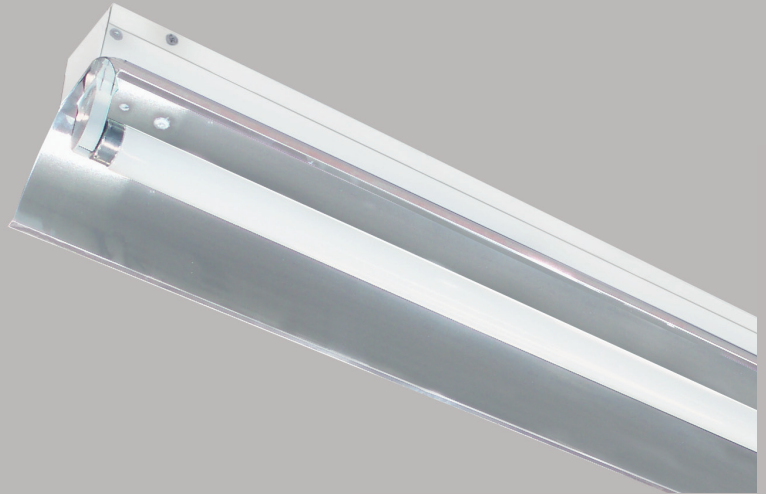

Order Code	Dim A	Dim B	Dim C	Lamps	Wattage
RL128/54*	1233mm	140mm	89mm	1	28/54w T5
RL228/54*	1233mm	140mm	89mm	2	28/54w T5
RL135/49*	1533mm	140mm	89mm	1	35/49w T5
RL235/49*	1533mm	140mm	89mm	2	35/49w T5
RL136HF	1233mm	140mm	89mm	1	36w T8
RL236HF	1233mm	140mm	89mm	2	36w T8
RL158HF	1533mm	140mm	89mm	1	58w T8
RL258HF	1533mm	140mm	89mm	2	58w T8
RL170HF	1833mm	140mm	89mm	1	70w T8
RL270HF	1833mm	140mm	89mm	2	70w T8
** High Rack Ref	x	165mm	125mm	x	x

*Please state wattage when ordering

Control Suffix

DA	DALI Dimmable
DSI	DSI Dimmable
TD	Touch Dimmable
AD	1-10v Analogue Dimmable
EL	3 Hour Integral Emergency
ELST	Self Test Emergency 3 Hour

Controller Suffix

HR	** High Rack Reflector
WR	White Reflector