











Wallwasher R

IP20 CE

The Recessed Wallwasher Luminaire Has An Asymmetric Light Distribution Which Is Ideal For Illumination Of Walls, Display Shelving And Other Vertical Surfaces

-  Body constructed from white coated steel.
-  Asymmetric aluminium specular reflectors.
-  Designed to suit both 15mm and 25mm T-bar ceilings.
-  Supplied as standard with leading brand high frequency control gear.
-  Continuous run or stand alone mounting.
-  Terminals positioned on back of fitting avoiding the need to remove the reflector to wire in, as is very common with this type of fitting.

Available options

-  Energy saving control gear options including analogue dimming, digital dimming, movement and daylight sensing.
-  Wiring configurations such as dual circuit, Through wiring and various plug and socket choices all aimed at saving time and effort at installation stage.

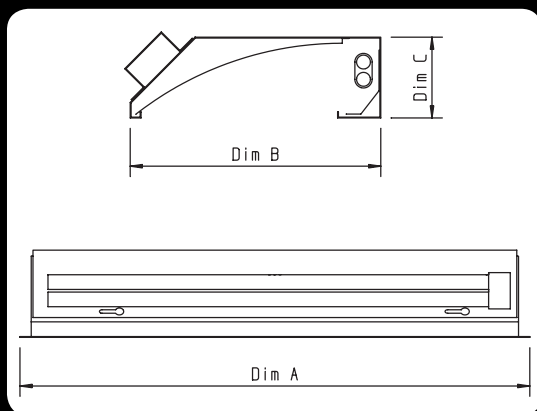
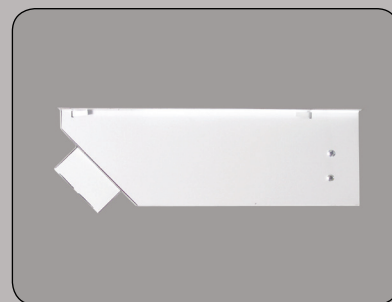

Order Code	Dim A	Dim B	Dim C	Lamps	Wattage
WWR114/24*	590mm	290mm	94mm	1	14/24w T5
WWR214/24*	590mm	290mm	94mm	2	14/24w T5
WWR128/54*	1190mm	290mm	94mm	1	28/54w T5
WWR228/54*	1190mm	290mm	94mm	2	28/54w T5
WWR140	590mm	290mm	94mm	1	40w PLL
WWR240	1190mm	290mm	94mm	2	40w PLL
WWR155	590mm	290mm	94mm	1	55w PLL
WWR255	1190mm	290mm	94mm	2	55w PLL
WWR180	590mm	290mm	94mm	1	80w PLL
WWR280	1190mm	290mm	94mm	2	80w PLL

*Please state wattage when ordering

Control Suffix

DA	DALI Dimmable
DSI	DSI Dimmable
TD	Touch Dimmable
AD	1-10v Analogue Dimmable
EL	3 Hour Integral Emergency
ELST	Self Test Emergency 3 Hour